

## MRT330.18-413F3D

### Thyristors module

#### Features:

- Pressure contact technology with increased power cycling capability
- Glass passivated chip
- Simple mounting
- UL recognized, file no. E312789

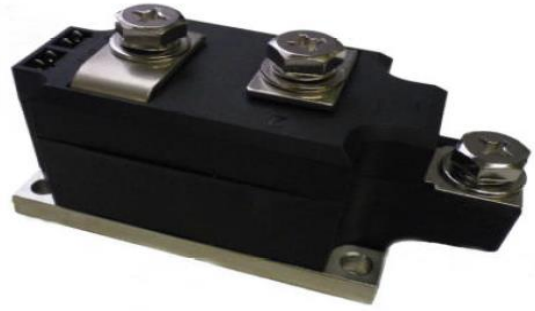

#### Typical applications:

- Power converters
- Lighting control
- DC motor control and drives
- Heat and temperature control

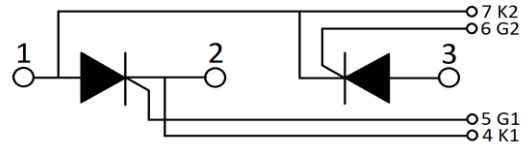

Symbol	Characteristics	Test Conditions	Value			Unit
			Min	Typ	Max	
$V_{RSM/DSM}$	Non-repetitive reverse/forward blocking voltage	$T_j = 25^\circ\text{C}$			1900	V
$V_{RRM/DRM}$	Repetitive reverse/forward blocking voltage	$T_j = 25^\circ\text{C}$			1800	V
$I_{T(AV)}$	Mean on-state current	$180^\circ$ half sine wave 50Hz			330	A
$I_{T(RMS)}$	RMS on-state current	$T_c = 85^\circ\text{C}$			518	A
$I_{RRM}$ $I_{DRM}$	Repetitive peak current	at $V_{DRM}/V_{RRM}$ $T_j = 125^\circ\text{C}$			25	mA
$I_{TSM}$	Surge non repetitive current	10ms half sine wave $V_R = 60\% V_{RRM}$ $T_j = 125^\circ\text{C}$			9.1	kA
$I^2 t$	$I^2 t$ for fusing coordination				414	$\text{kA}^2\text{s}$
$V_{TO}$	Threshold voltage	$T_j = 125^\circ\text{C}$			0.80	V
$r_T$	On-state slope resistance	$T_j = 125^\circ\text{C}$			0.53	$\text{m}\Omega$
$V_{TM}$	Peak on-state voltage	$T = 25^\circ\text{C}$ ; $I_T = 750\text{A}$			1.45	V
$dv/dt$	Critical rate of rise of off-state voltage	$V_{DM} = 67\% V_{DRM}$ , $T_j = 125^\circ\text{C}$ , linear voltage rise			800	$\text{V}/\mu\text{s}$
$di/dt$	Critical rate of rise of off-state current	$T_j = 125^\circ\text{C}$ , Gate source 1,5A, $I_{TM} = 500\text{A}$ , $T_r < 0,5\mu\text{s}$ Repetitive			100	$\text{A}/\mu\text{s}$
$I_{GT}$	Gate trigger current	$V_A = 12\text{V}$ , $I_A = 1\text{A}$ , $T_j = 25^\circ\text{C}$	30		180	mA
$V_{GT}$	Gate trigger voltage		1.0		2.5	V
$I_H$	Holding current		20		180	mA
$V_{GD}$	Non-trigger gate voltage	$V_{DM} = 67\% V_{DRM}$ , $T_j = 125^\circ\text{C}$	0.2			V
$R_{th(j-c)}$	Thermal resistance junction to case	Single side cooled per chip			0.12	$^\circ\text{C}/\text{W}$
$R_{th(c-s)}$	Thermal resistance case to sink	Single side cooled per chip			0.04	$^\circ\text{C}/\text{W}$
$V_{ISO}$	Isolation voltage	50Hz, RMS, $t = 1\text{min}$ , $I_{ISO} : 1\text{mA (MAX)}$	2500			V
$F_M$	Mounting torque - copper plate (M6)			6.0		N·m
	Mounting torque - terminal (M8)			12.0		N·m
$T_{stg}$	Storage Temperature		-40		125	$^\circ\text{C}$
$T_j$	Operating Temperature		-40		125	$^\circ\text{C}$
$W_t$	Weight			820		g
Outline	413F3D					

## MRT330.18-413F3D

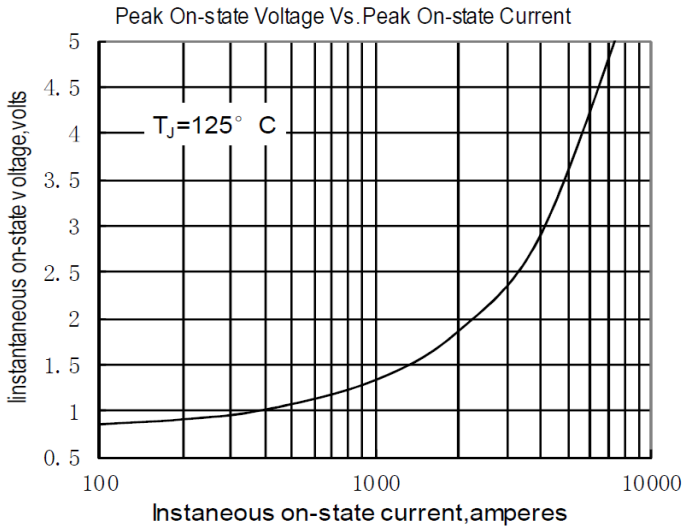

Fig. 1

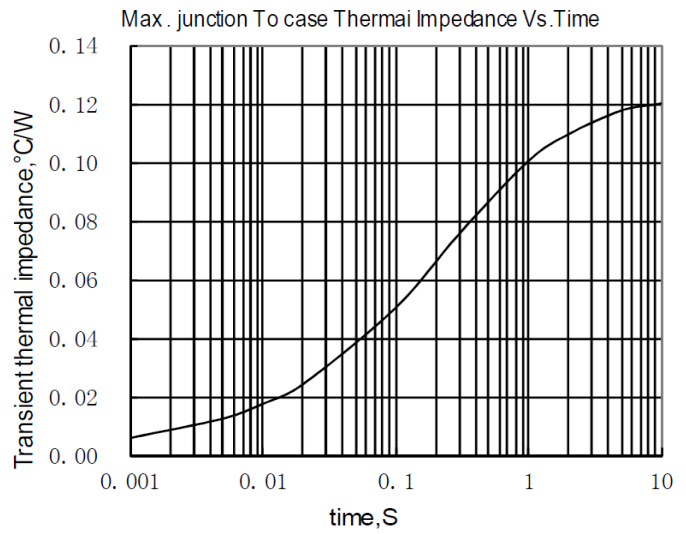

Fig. 2

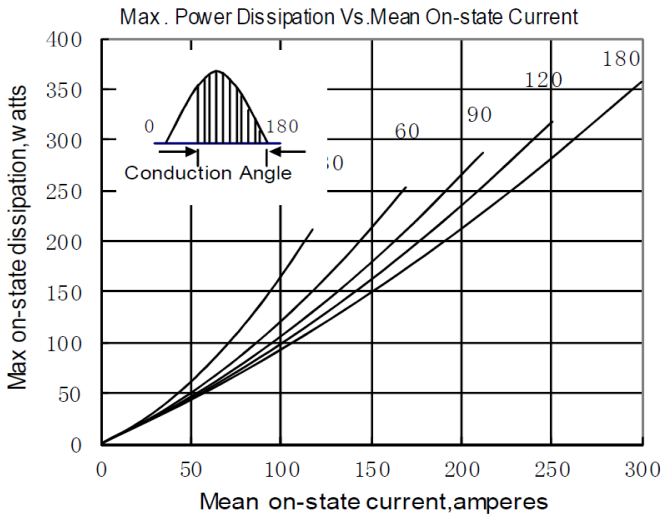

Fig. 3

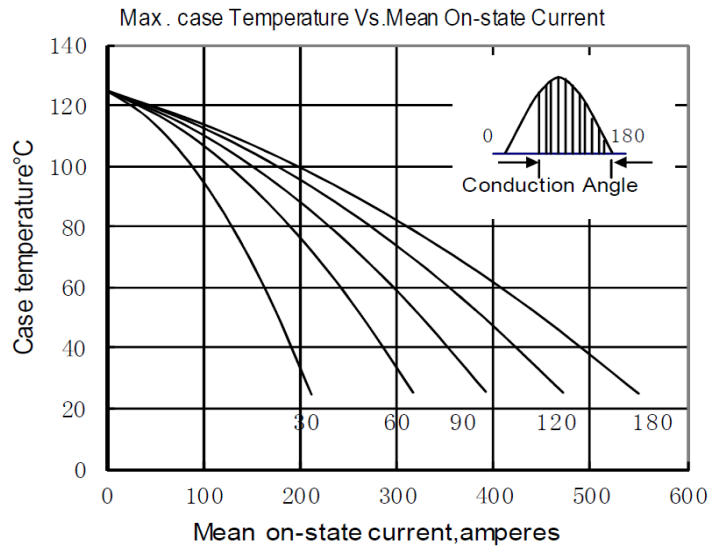

Fig. 4

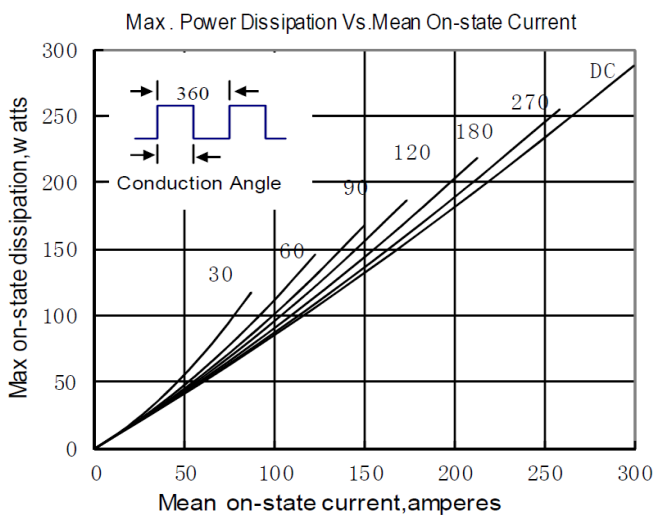

Fig. 5

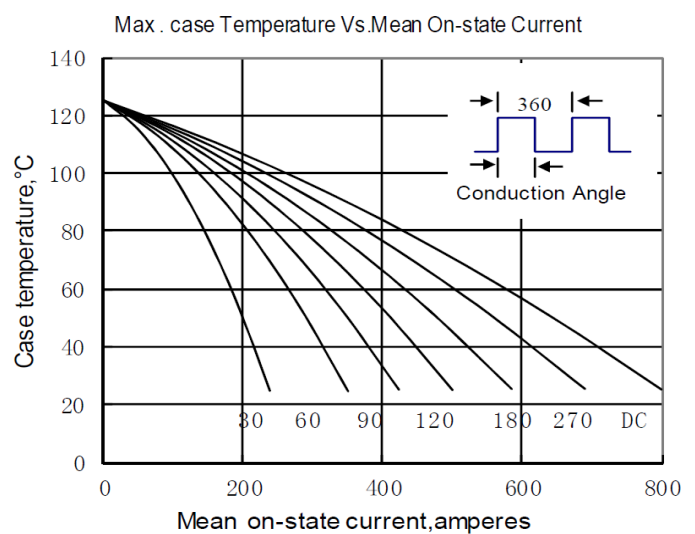

Fig. 6

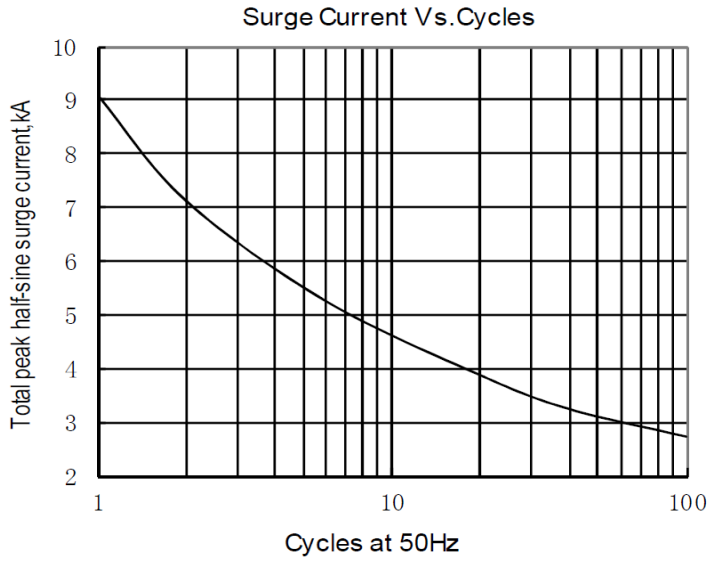

Fig.7

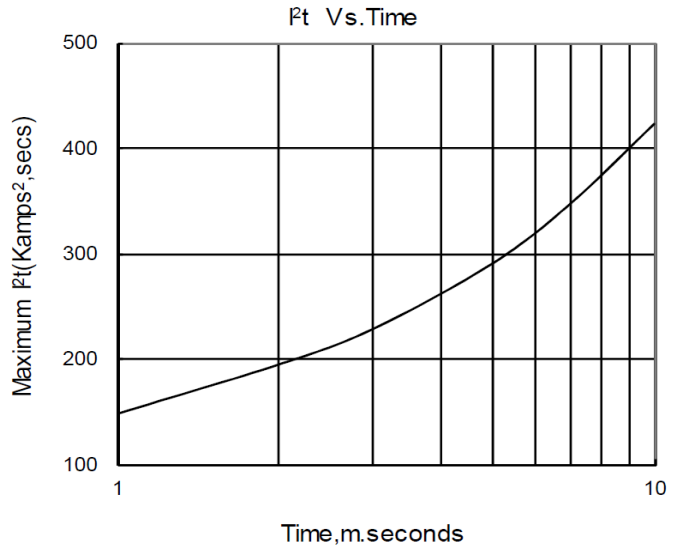

Fig.8

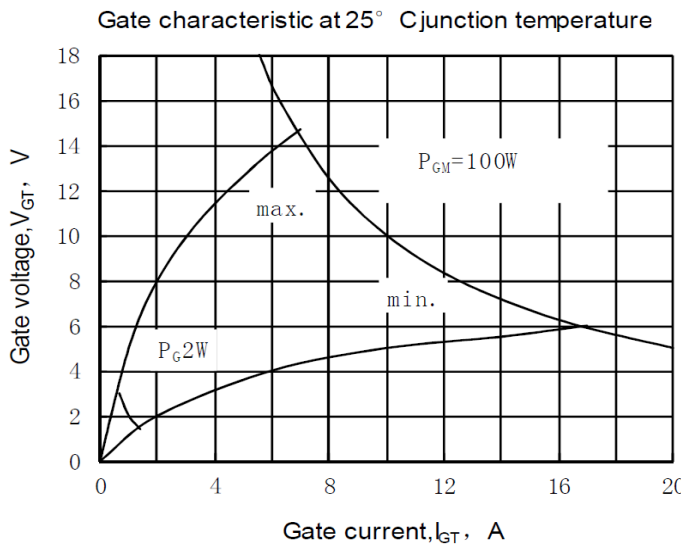

Fig.9

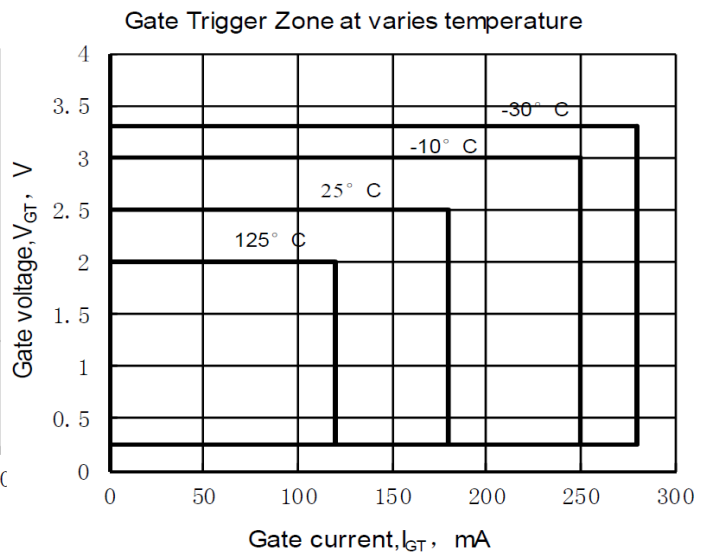
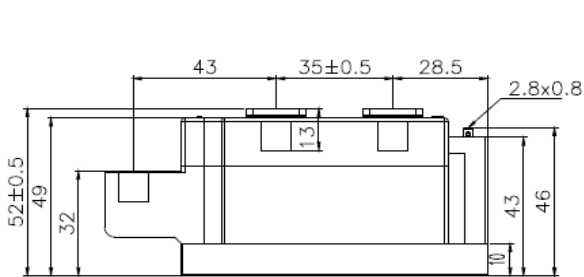
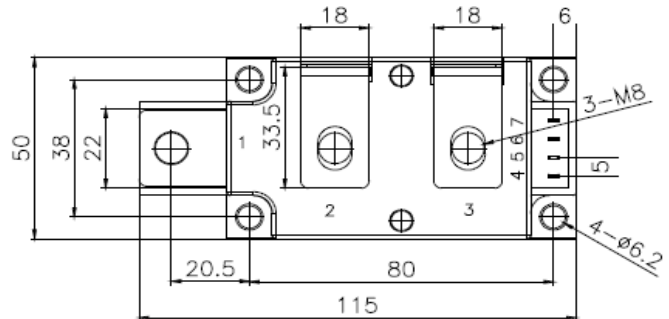

Fig.10

Outline:



(dimensions in mm)



**S.CO.M.E.S. Srl**

Via Enrico Mattei, 6/8 - 26283 - Castiglione d'Adda (LO) - Italy

Phone: +39 0377 901243 Fax: +39 0377 900206